

Instruction Manual

Refrigerator

No frost

Model

R-WB640VT0X



Thank you very much for purchasing the Hitachi refrigerator.
Before installation and usage, please read the user's guide carefully
for the correct usage.

Maintenance work must only be carried out at workshop
by well-trained maintenance work.



Refrigerator Installation
(English Version)

HITACHI

Content

Preparation for Use	
Warning and Caution for Safety	2
Preparations before Use	4
■ Installation.....	4
■ Beginning.....	4
■ Food Storage.....	4
Location of Food Storage	5
Operation	
ECO Monitoring Sensor	5
How to use Auto Door	6
How to use the Control panel	6
■ Name and Function of the Control Panel....	6
■ Temperature Control.....	7
Other functions	7
Refrigerator / Selectable Zone /	
Freezer Compartment	10
■ How to use Auto Ice Maker.....	11
■ Swing Partition Suggestion.....	11
■ How to use Vacuum Compartment.....	12
■ How to remove part.....	13
Maintenance	
Care and Maintenance	14
■ Cleaning.....	14
Troubleshooting	16
Dew or Frost is generated	19
Service Center	20

For household use only

R600a
Refrigerant

Warning and Caution for Safety

To avoid harm to the user, other persons or damage to property, please read and follow the warnings and cautions below and those given throughout this manual.

The following warnings and cautions are categorized by the level of possible harm or damage that may occur from ignoring directions.

This symbols are shown as below clearly showing the significance of directions.

	WARNING	This pictograph indicates "There is a high possibility of serious injury or death, if ignored".
	CAUTION	This pictograph indicates "There is a high possibility of sinjury or damage to property, if ignored"

- This refrigerator use flammable refrigerants. The symbol column below states the precautions on flammable refrigerants.

The symbols below are examples.	
	This symbols is an alert mark.
	This symbols indicates "prohibited".
	This symbols indicates "necessary".



This symbol denotes the precautions on flammable refrigerators.

WARNING

When you install ... To avoid fire, electric shock, and injury.

- Do not install the refrigerator in a place where it may come in contact with water.
- Do not install the refrigerator in a place exposed to rain.
 - This may impair electricity insulation and cause electric shock or fire.
- Ground this refrigerator to prevent electric shock and noise interference. Always ground this refrigerator and install earth leakage circuit breaker when using it in please with high humidity or moisture. (Please consult with a retailer or Hitachi Service Center.)





















Power Cord and Power Plug ... To avoid fire, electric shock.

- Do not connect the wall outlet whose power capacity is less than the refrigerator's. Also, do not use power sources that are not a rated voltage.
 - If a power source is shared with other appliances using double or multipoint adapters, the adapter
 - Do not locate multiple portable socket-outlets or portable power supplies at the rear of the appliance.
- Do not use a damaged or loose power plug or power outlet. This may cause fire or electric shock.
- Do not cut, bend, fold the power cord to avoid fire and electric shock.
 - When positioning the appliance, ensure the supply cord is not trapped or damaged.
- Be sure to unplug the power plug before maintaining the refrigerator.
 - Be sure to hold the power plug to unplug.
- Connect the power plug firmly to a power outlet with the cord running down.
 - Connection of the power plug with the cord running up could apply stress on the cord and cause electrical short or overheat, which could result in electrical shock or fire.
 - Incomplete connection of the power plug could result in electrical shock or fire due to heat.
- If the supply cord is damaged, it must be replaced by the manufacturer, its service agent or similarly qualified persons in order to avoid a hazard.
- Clean the dust on the power plug frequently with dry cloth.
 - Unplug the power plug and wipe it with dry cloth.
 - An insulation failure due to moisture or when dust collects on the power plug may cause fire.
- Do not insert or remove the power plug with wet hands.

During daily use ... To avoid fire, electric shock.

- Do not splash water on or inside the refrigerator.
 - This may impair electricity insulation causing electric shock or fire.
 - This may also cause gas leakage because of pipe rust.
- Do not disassemble, repair, or modify the refrigerator by yourselves.
 - Please consult with a retailer or Hitachi Service Center if any repair is required.
- Ether, liquid propane gas, solvent, aerosol cans, etc. which is volatile cannot be stored in this refrigerator.
 - Do not store anything that are generate heat or fire spark inside the refrigerator.
- This appliance is not intended for use by persons (including children) with reduced physical, sensory or mental capabilities, or lack of experience and knowledge, unless they have been given supervision or instruction concerning use of the appliance by a person responsible for their safety.

! WARNING











-  Do not hang on the doors or step up on the various compartments.
 - Injury may be caused by the refrigerator tipping over or hands getting caught in door.
- Do not enter in the refrigerator. 
-  Do not damage the refrigerant circuit.
 - If there the damage of refrigerant pipe happened, stay away from the refrigerator and avoid using fire and electrical appliances.
 - And, open windows to ventilate and contact retailers or Hitachi Service Center.
-  Do not use electrical appliances inside the food storage compartments of the appliance, unless they are of the type recommended by the manufacturer. 
-  In an event of a flammable gas leak, do not touch the refrigerator and open windows for ventilation.
 - Sparks from points of electrical contacts such as door switches may ignite explosions causing fire or a burn.
-  Do not use the refrigerator in the atmosphere of flammable gas. 
-  Do not make an impact on the glass-made doors or shelves.
 - They are made of tempered glass, however, an excess impact may be result in breakage and is dangerous.
-  When an infant child may use the Auto Door to make mischief, Please stop the Auto Door function.
- This appliance is intended to be used in household and similar applications such as
 - Staff kitchen areas in shop, offices and other working environments.
 - Farm houses and by clients in hotels, motels and other residential type environments.
 - Bed and breakfast type environments.
 - Catering and similar non-retail applications.
-  Do not put water containers or foreign articles on the top of the refrigerator.
 - Opening and closing doors etc. may cause the articles on the top of the refrigerator to fall down, resulting in injury.
-  Medicines, chemicals, research and experimental substances should not be stored in the refrigerator.
 - Substances that require precise conditions for storage cannot be stored in a domestic refrigerator.
-  Do not use mechanical devices or other means to accelerate the defrosting process, other than those recommended by the manufacturer. 
-  Children should be supervised to ensure that they do not play with the appliance.
 - Children getting inside may not be able to get out.
- Cleaning and user maintenance shall not be made by children without supervisor. 
- This appliance can be used by children aged from 8 year sand above and persons with reduced physical, sensory or mental capabilities or lack of experience and knowledge if they have been given supervision or instruction concerning use of the appliance in a safe way and understand the hazards involved.
- Children shall not play with the appliance.
- Children aged from 3 to 8 years are allowed to load and unload refrigerating appliance.
-  Keep ventilation openings in the appliance enclosure or in the built-in structure clear of obstruction. 
-  If you find something wrong with the refrigerator, immediately unplug and consult with the retailers or Hitachi Service Center. 

When discarding the refrigerator.

-  When discarding the refrigerator, remove the door gaskets.
 - To avoid a risk of an infant or child to be entrapped inside.
-  Follow the instructions of your region when discarding.
 - This refrigerator uses R-600a for the refrigerant and cyclopentane for the blowing agent of the urethane heat insulation.

! CAUTION

During daily use ...To avoid illness and injury.

-  Do not put bottles, etc. forcibly in the door pockets.
 - This may cause bottles to drop down or door pockets to come off.
-  Do not store food which smells or food whose color is changed abnormal.
 - Such an action may cause diseases.
-  Food and containers inside the freezer compartment should not be touched with wet hands.
 - This may cause frost injury. (Especially in case of metal items.)
-  Do not hold the top, bottom and side of the doors when closing them.
 - This may result in your fingers being caught by the door edge.
-  If someone else is using the refrigerator, do not open the door.
 - Fingers may get caught in the spaces between the doors and may cause injury.
-  Be careful not to operate the Auto Door when another person is in front of the refrigerator, which may lead to personal injury unexpectedly caused by the opening door.
-  Do not have food items protruding over the front edge of each shelf.
 - Doors may not be closed properly or the door pockets may drop down. Injury may be caused from items like bottles getting knocked over your feet.
-  Do not store glass bottles in the freezer compartment.
 - Bottles may break by the contents freezing and cause injury.
-  Do not put your hands into the base surface of the refrigerator cabinet.
 - When cleaning, putting your hands near the base surface of the frigerator may result in injury by thin metal sheets.
-  Be sure to hold the handle firmly to open or close the door.
-  Do not have your feet too close when opening the door of the refrigerator.
 - When opening the door, your feet may be hit, resulting in injury.

⚠ CAUTION

When moving or carrying ... To avoid damaging, wetting, soiling the floor, or to avoid injury.

- ❗ Use the carrying handle when carrying the refrigerator.
 - Hold the carrying handles only. If hold door handles, hands may slip and may cause injury.
 - Carry the refrigerator by at least 4 persons for safety reasons.
 - Carry it with the doors facing upward.
- Before carrying the refrigerator:
 1. Take out all food items and ice cubes.
 2. Lay a protective sheet or cloth to protect the floor from damage and catch remaining water spilled from the refrigerator.
 3. With a large piece of old cloth underneath, tilt the refrigerator backward to drain water.
 4. Finally carry the refrigerator with the doors facing upward.
 - Secure the doors well with adhesive tapes so they do not open.
 - If transporting in a vehicle, do not load the refrigerator on its side. This could damage the compressor.

- ❌ Do not use door handles and ECO monitoring sensor when carrying the refrigerator.
- ❌ Never use the carrying handles to hang up with a chain hoist or similar machines.
- ❌ On a floor that is easily scratched, do not move the refrigerator with the wheels of refrigerator.
 - The wheels may scratch the floor.
 - For a floor that may be easily scratched, lay a protective mat, etc..



When replacing lamps (LED) is required.

- ❗ When lamps (LED) need to be replaced, please contact Hitachi Service Center.

Preparations before Use

1 Installation

- 1) Install on a rigid and level floor.
- 2) Please use this refrigerator between the room temperature of 10°C to 43°C Sufficient performance may not be obtained, if room temperature is too low or too high.
- 3) Do not install where the refrigerator is exposed to direct sunlight or other heat source.
- 4) Install in an atmosphere which is dry or has air ventilation.
- 5) The refrigerator requires enough air ventilation space around the cabinet to have efficient cooling performance. Space of at least 100 mm over the top, 100 mm at rear and 70 mm at both sides for proper air circulation is needed.
- 6) Ground the refrigerator to prevent electric shock and noise interference. Always ground this refrigerator when using it in place with high humidity or moisture. (Please consult with retailers or Hitachi Service Center.)
- 7) Adjusting the adjustable legs to keep the left/right refrigerator door level,
 - Without adjusting the legs, door height may not be level, or there may be abnormal vibration or noises depending on floor conditions. Follow the instructions below.
 - Turn the adjustable legs until they touch the floor firmly.

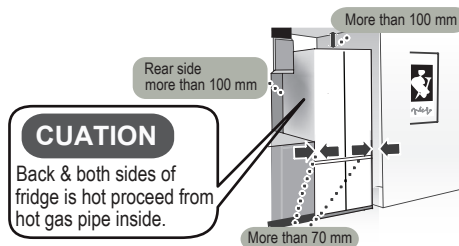
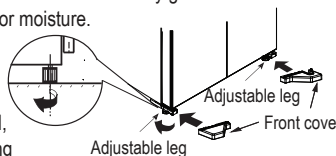

CAUTION

Back & both sides of fridge is hot proceed from hot gas pipe inside.

Parallel adjustment of the door.

Left door has fallen Right door has fallen



Adjustable left leg.



Adjustable right leg.

- Please turn the left leg in the direction of the arrow. Please turn the right leg in the direction of the arrow.
- 1 rotation of adjustable leg is about 1mm in difference.
 - 1-5 days might take for the main body of the refrigerator becomes familiar with the floor, and until the door is reconciled in parallel.

2 Beginning

- 1) After transporting : If Refrigerator has been kept horizontal position for more than 10 minutes for transportation or any other reasons, it should stand upright for more than 1 hour before plugging it in.
- 2) Cleaning inside the refrigerator. Wipe the surface gently with soft cloth.
- 3) Connect the refrigerator to an exclusive wall power outlet. The refrigerator can be connected to an outlet soon after it is installed. Surely use with the rated voltage and exclusive power outlet.
- 4) The compressor will start running in approximately 30 seconds, if inside is not cold.
- 5) Allow enough duration for sufficient cooling before storing food. It may take about 4 hours to fully cool down and could even take about 24 hours when the ambient temperature is high.
- 6) Opening the door for long periods can cause a significant increase of the temperature in the compartments of the appliance.

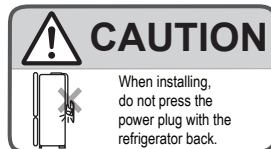
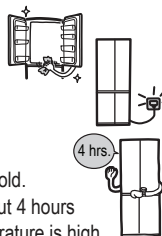

3 Food storage

- 1) Keep enough space between food. Several food placed too close together may obstruct the flow of cold air.
- 2) Make food cool enough before putting it in the refrigerator. Putting warm food in the refrigerator raises the inside temperature and wastes electricity.
- 3) Do not block the cold air vent. This will adversely affect the cold air flow and may not keep the temperature inside even. Moreover, it could result in food near the vent freezing.
- 4) Using plastic wrap or sealed containers prevent the food from drying or transition of smells.
- 5) Store raw meat and fish in suitable containers in the refrigerator, so that it is not in contact with or drip onto other food.

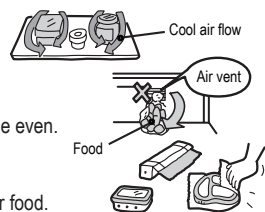

Location of Food Storage

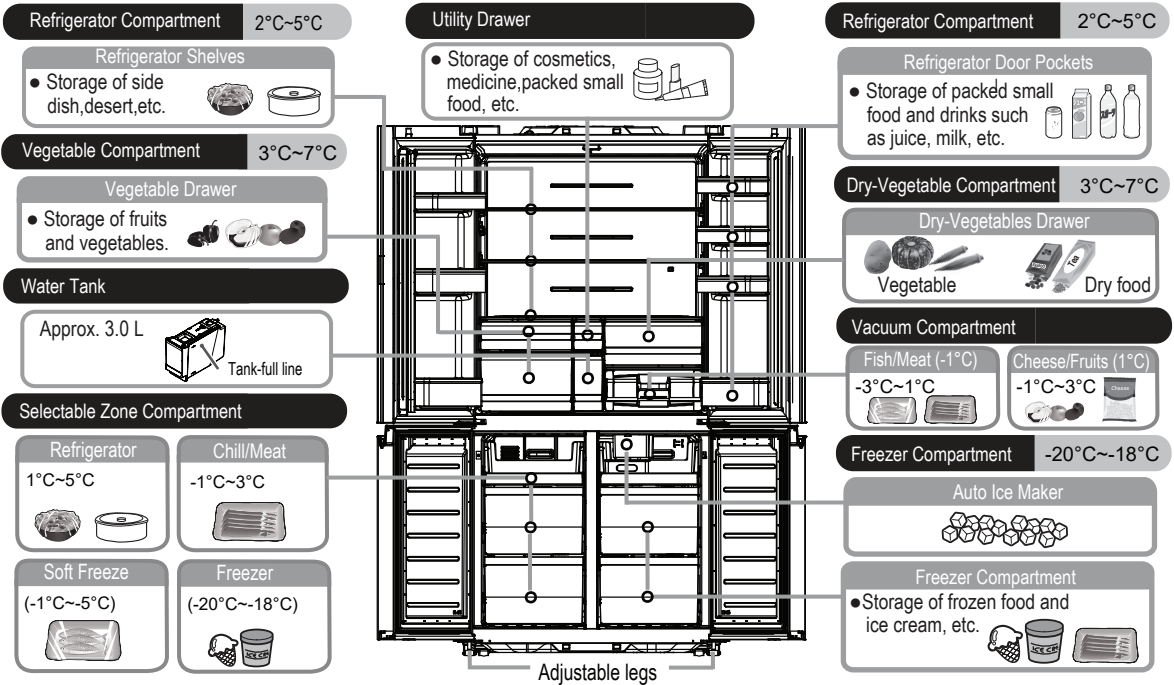

NOTICE

- Above temperatures are the approximate values in the conditions of outside temperature 32°C, the temperature setting of the refrigerator compartment "Normal", freezer compartment "Normal", doors being closed and without food storage.
- Door pocket temperatures may be slightly higher than above temperatures.
- The specification of your purchased model may be different from one of the above illustration.
- One-, two- and three-star compartment are not suitable for the freezing of fresh food.
- Two-star frozen-food compartment are suitable for storing pre-frozen food, storing or making ice cream and making ice cubes.

ECO Monitoring Sensor

ECO Monitoring Sensor

- The controller section is displayed automatically only when the refrigerator is used and provides guidance in a user-friendly manner.

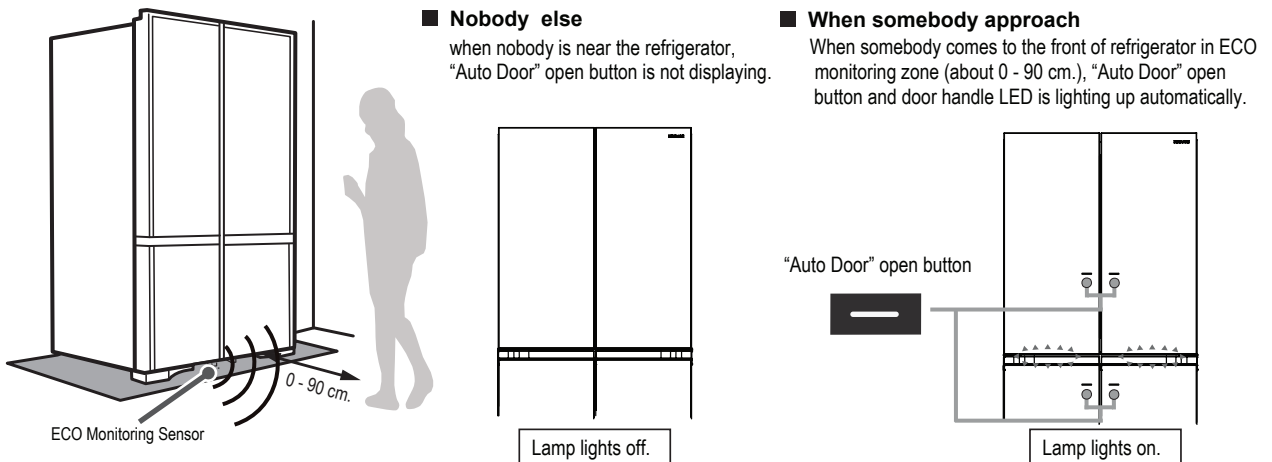

CAUTION

- Avoid placing the refrigerator in the hallway or areas where the most peoples walk through it.
- ECO Monitoring Sensor can detect people near refrigerator only.
- If the sensor cover dirty may cause sensor error. Always clean it with dry cloth.
- Do not put any things in the detecting area.

NOTICE

- When the ECO Monitoring Sensor does not work. You can light up the touch screen button as follows
- Open any door.
 - Touch any on button area.

How to use Auto Door

You can open the door easily by touching the door lightly with your thanks to the Auto Door function.

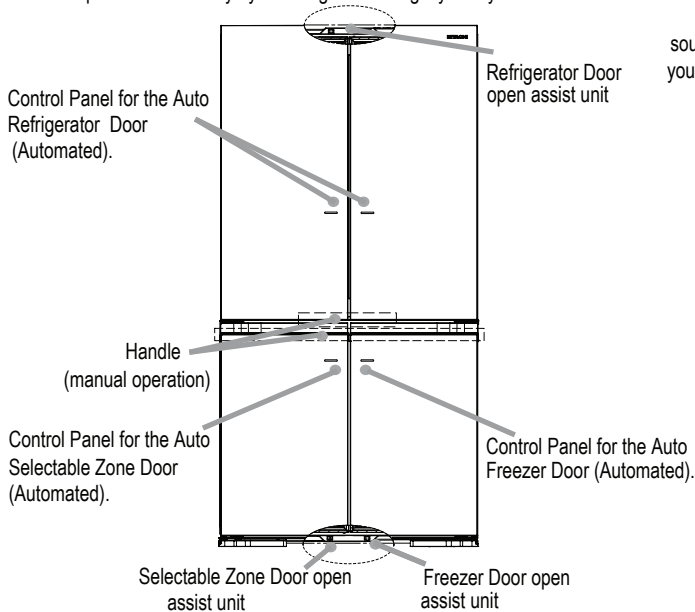

When touching "Auto Door" button, the operation sound is heard, and then it will open automatically. When closing it, use your hand to close the door (not electrically operate).

1 Opening one door on either side.

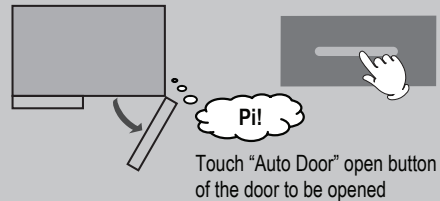

2 Opening both doors at a time.

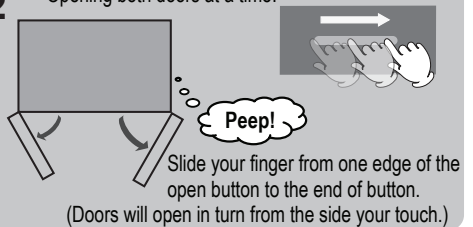

CAUTION

- When an infant child may use the Auto Door of make mischief, please stop the Auto Door function . (P.9)
- Use fingers to operate the control panel.
- Do not operate the Auto Door when another person is in front of the refrigerator or opening door (which may lead to personal injury unexpectedly by the opening door.)
- Be sure to unplug the power before cleaning the Auto Door.
- Do not put any item on the refrigerator.

NOTICE

- Auto door is the function to reduce the load when opening the refrigerator door. Opening angle of the door may vary or the door may go back a little after it is opened automatically depending on installation conditions of the refrigerator how beverages or foods are stored in the door pocket, but this is not malfunction.
- Auto Door of the Refrigerator Compartment will not be opened, When door of vegetable compartment opened.
- After touching the open button for the Auto Door, the operation sound may be heard when opening the door, but this is not malfunction.
- If open button for the Auto door is wet or dirty, it may not respond. Use wet cloth to wipe off dirt, and then wipe it with a dry cloth.
- If you touch the open button for the Auto Door and its neighbouring part at the same time, or you touch it for about one second or more, the Auto Door may not be opened automatically.

How to use the Control Panel

Name and Function of the Control Panel

1

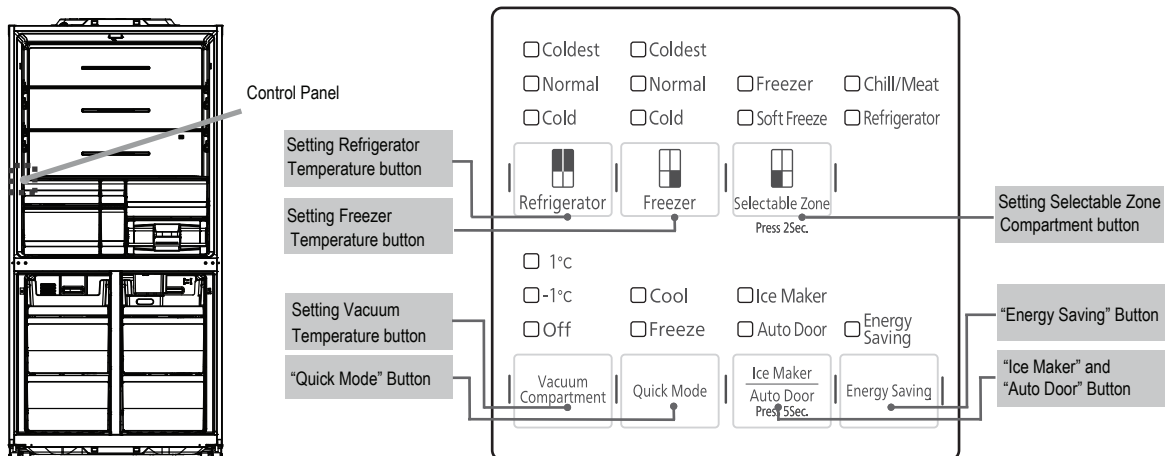

NOTICE

- If you unplug the power plug or a power failure occurs, then the refrigerator restart, the temperature display and each setting will be automatically resumed. However "Quick Freezing" and "Quick Cooling" operation will be cancelled.
- There must set more than 45 seconds before unplug the power or power failure. otherwise the temperature display shown as before setting.

How to use the Control Panel

2

Temperature Control

■ Refrigerator Compartment

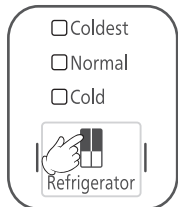

Press "Refrigerator" button, To setting a temperature.

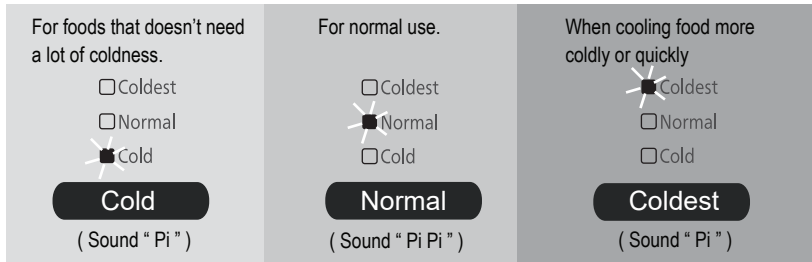

The display is indicating the status of temperature setting.

■ Freezer Compartment

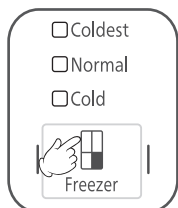

Press "Freezer" button, To setting a temperature.

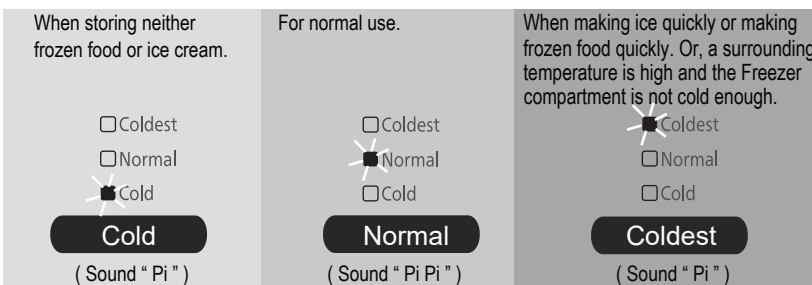

The display is indicating the status of temperature setting.

■ Selectable Zone Compartment

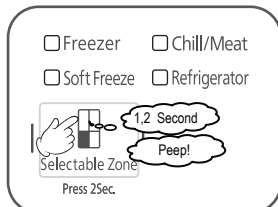

Press "Selectable Zone" button, 2 seconds for unlock. To select Selectable Zone Compartment mode

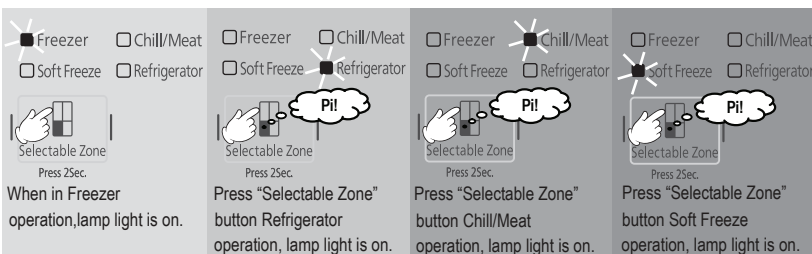

The display is indicating the status of temperature setting.

NOTICE

- "Refrigerator" mode : Storing of Vegetable or fruits are required to be wrapped (Poly bag or Vacuum bag), to prevent from drying or freezing.
- By using Poly bag or Vacuum bag require extra attention to avoid humidity (Depends on Weather, Area etc.) accumulation.

Other Functions

■ Door Alarm and ECO Alarm Function

If the door is left open for more than 1 minute, the alarm system will inform the user by the sound and digital display.

- Door Alarm: Informs by PeepPeepPeep sound.
- Eco Alarm Display: Indicates the door opening state on the control panel.

To Disactivate Alarm and Sound

1. Keep pressing "Quick Mode" button for 5 seconds until "Peep!" sound is heard.
2. There is not sound when pressing any button (deactive door alarm sound).

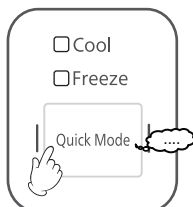
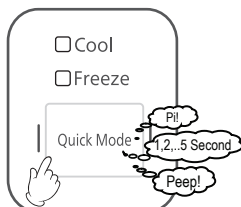

To re-activate Alarm and Sound

1. Keep pressing "Quick Mode" button for 5 seconds until "PiPi!" sound is heard.
2. There is sound when pressing any button (active door alarm sound).

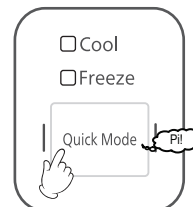
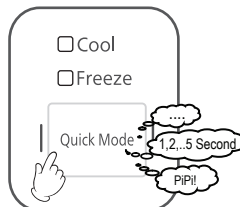

NOTICE

- Factory setting, the alarm and sound are set "ON"
- If the Door Alarm, Eco Alarm Display and each button operation sound have been deactivated, The refrigerator will still set the alarm and sound to "OFF" even though a power failure or when unplugging and reconnecting the power plug.
- There must set more than 45 seconds before unplug the power or power failure. otherwise the temperature display shown as before setting.

Other Functions

■ How to use temperature control 9 step (Refrigerator compartment/ Freezer Compartment)

Setting

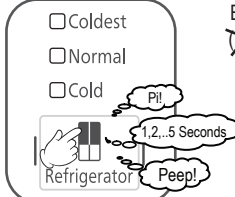

Press "Refrigerator" button for 5 seconds until 1 "Peep!" sound is heard.

Cancel

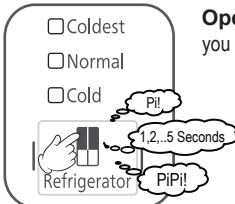

Open the Refrigerator door before press "Refrigerator" button to cancel.

you can set temperature by normal step (3 steps)

Press "Refrigerator" button for 5 seconds until 1 "PiPi!" sound is heard.

Open the Refrigerator door before press "Refrigerator" button to setting.

Each time you press the button, the corresponding indicator lamp changes in order shown below (9 steps).

Lighting ■ Blinking □ Turned off

Indication lamp	□	□	■	■	■	■	■	■	■	□	□
Setting	Cold	→	→	→	Normal	→	→	→	→	→	Coldest
Sound	Pi!	Pi!	Pi!	Pi!	PiPi!	Pi!	Pi!	Pi!	Pi!	Pi!	Pi!

NOTICE

- This function is subjected to change according model type.
- Factory setting, the adjustment temperature by normal step (3 steps).

■ Quick Mode

Quick Freezing : When you want to freeze food or make ice quickly, use this function.

Quick Cooling : When you want to cool food or drinks quickly, use this function.

1



Press "Quick Mode" button for Start Quick Freezing operation, lamp light is on.

"Quick Freezing" will be finished automatically in approximately 2 hours.

2

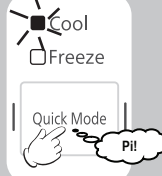

Press "Quick Mode" button for Start Quick Cooling operation, lamp light is on.

"Quick Cooling" will be finished automatically in approximately 90 minutes.

3



Press "Quick Mode" button for start two function operation, both lamp light are on.

4

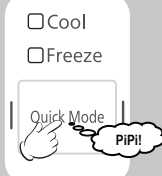

Press "Quick Mode" button for stop two function operation, both lamp light are off.

Quick Freezing

Put food on the quick freezing "Quick Freezing" corner is located located on the upper part of the freezer compartment.

"Quick Freezing" is more effective if food is place near the back wall of the freezer compartment.

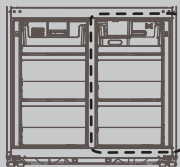

Quick Cooling

Put food on the quick cooling "Quick Cooling" corner is located on the upper part of the refrigerator compartment.

"Quick Cooling" is more effective if food is place near the back wall of the refrigerator compartment.

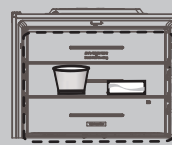

NOTICE

- During "Quick Freezing", priority cooling of the freezer compartment will be done, Thus, try to avoid unnecessary opening and closing the doors not to have a temperature rise of the refrigerator compartment.
- During defrost period, "Quick Freezing" and "Quick cooling" operation will stop even though the lamp is on. After finishing defrost period, the operation will restart automatically.
- Please note "Quick Freezing" and "Quick Cooling" mode will be released after power cut off or unplug.

Other Functions

- **Vacuum** The display switches in sequence as shown below everytime the button is touched. The temperature is set to “-1°C” at default.

1

When in “Vacuum Compartment” button “-1 °C” operation. Lamp lights on.

2

Press “Vacuum Compartment” button to start Vacuum 1°C operation. “1°C” lamp light is on.

3

Press “Vacuum Compartment” button for stop Vacuum operation. “off” lamp light is on.

After off vacuum function, the temperature will be automatically to default (-1 °C)

CAUTION The “Off” indicator lamp continues to be lit during the “Off” operation.

■ Ice Maker / Auto Door

Ice Maker : First, check whether the Automatic Ice Maker is in operation.

1

Press button for start Ice Maker operation, lamp light is on.

2

Press button again for stop Ice Maker operation, lamp light is off.

When you wish to make ice especially quickly, use the “Quick Freezing” function.

Ice Preparation Time (8 (eight) cubes / ice making cycle)

Normal Operation	Approx. 90 to 110 minutes
Quick Freezing	Approx. 70 to 90 minutes

The Ice Preparation Time shown is the average time to make ice when the ambient temperature is 32°C and the door is not opened and closed and temperature setting “normal”.

NOTICE

- When using the “Auto Ice Maker” for the first time, discard the first of ice cubes for cleaning.
- If you do not intend to use the Automatic Ice Maker, manually cancel its operation.
- Ice cannot be made until the interior of the refrigerator is sufficiently cool. It may take 24 hours or longer to make ice for the first time after installation. Normally, it only takes 2 to 3 hours to make 8(eight) ice cubes.
- The Ice Making Time will be longer in the following situations.
 1. When the door is frequently opened and closed
 2. When a large amount of food is placed inside the refrigerator at the same time
 3. After “Ice Tray Cleaning” has been run
 4. When there is a power outage
 5. During winter, or when the surrounding temperature is low
- When an infant child may use the Auto Door to make mischief please stop the Auto Door function.

Auto Door : You can prevent mischief of all the buttons on the control panel by children.

1

To activate this function, press button 5 seconds.

2

To stop this function, press button 5 seconds again.

NOTICE • When an infant child may use the Auto Door to make mischief please stop the Auto Door function.

Other Functions

■ **Energy Saving** Recommend to use this function in case of low storage volume, or a long vacation when the doors are not opened for long time.

1



- No ECO Monitoring sensor detection.
- No door open.
- No control panel operation.

Press "Energy Saving" button for Start Energy Saving operation, lamp light is on.

2

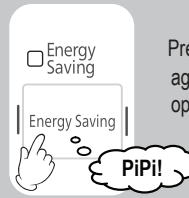

Press "Energy Saving" button again for stop Energy Saving operation, lamp light is off.

NOTICE

- In case the compartment temperature rises up, the operation will be back to a normal setting temporarily.
- After a long time operation of "Energy Saving", in some cases, fatty ice cream, etc, may become soft. Please stop "Energy Saving" operation in this case.
- If you Touch "Quick Freezing" or "Quick Cooling" button during "Energy Saving" operation, "Energy Saving" operation will be done after "Quick Freezing" or "Quick Cooling" operation finished.

CAUTION

- If "Energy Saving" operation is working in high humidity environment, dew may appear on refrigerator surface.

■ How to use Dry-Vegetable Drawer

If you keep the refrigerator in a hot and humid place, frequently open the door or store a lot of vegetables, it may cause dew forming which has no effect on its performance. Wipe the dew with dry cloth.

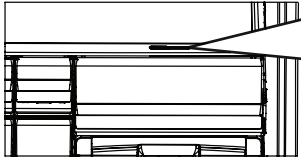

Dry Food Vegetable

Slide the lever to "Dry food" for coffee bean/tea leaf 3°C~7°C

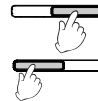

Slide the lever to "Vegetable" to provide temperature for vegetable and fruit 3°C~7°C

- There is a humidity control which can adjust the amount of dry air flowing into the drawer.

CAUTION

- Do not store dry food and vegetable together. Vegetable moisture may transfer to dry food and may not be able to keep food dry.

Refrigerator/Selectable Zone/Freezer Compartment

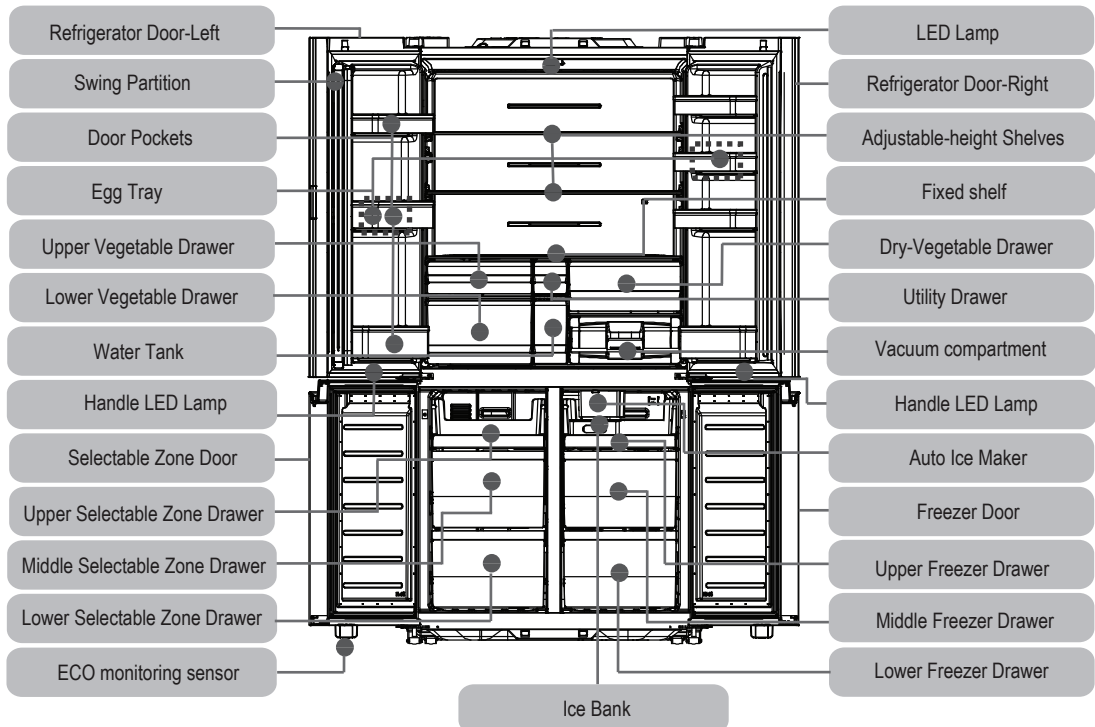

Refrigerator/Selectable Zone/Freezer Compartment

1 How to use the Auto Ice Maker

1. Remove the water tank.

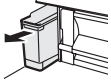

- Hold the handle and pull the water tank towards yourself.

3. Carry the water tank by the handle with care.

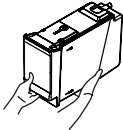

- When carrying the water tank, place one hand below the tank for horizontal stability.

2. Slide the Lid and fill the water.

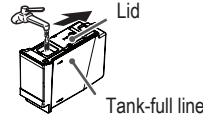

- Fill the water not over the full line.

4. Insert the water tank until it stops.



- If the water tank is not inserted all the way, water will not be supplied to the Automatic Ice Maker. This will prevent these features from functioning properly.

CAUTION

- Do not fill the Water Tank with anything other than water. Filling the Water Tank with fluids such as juice, sports drinks, tea, or hot water can damage your refrigerator. The Water Tank can withstand temperatures up to 50 C



Mineral water



Filtered water



Well water



Juice drink



Sports drink



Carbonated drink



Tea

NOTICE

- Germs can multiply quickly when filtered water, dechlorinated water, mineral water, or boiled water is used in the Water Tank. Be sure to thoroughly clean the Water Tank regularly.
- Change the water in the Water Tank once a week.
- When not using the Water Tank for extended periods of time, thoroughly clean and dry the water tank and reinstall it to its place in the refrigerator.
- The capacity of the Water Tank is approx. 3.0 liters.
- For a first installed, allow 24 hours for the refrigerator to cool down and make ice.
- Ice maker will stop automatically when ice bank is full and start again automatically when ice cubes in the ice bank is reducing or empty.
- It is normal that a noise is generated when ice made or ice dropped into the ice bank.

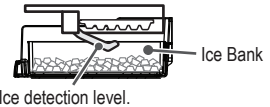

2 Swing Partition Suggestion

- Do not hold the swing partition while opening or closing the left door. Otherwise, other parts may collapse.
- Whenever the door is opened, the swing partition will close automatically. While the door is closed, the swing partition will open. Please follow as usual. The swing partition and the swing stopper hit each other, the door will not close.
- In order to prevent the dew, there is a heater installed inside to heat up the swing partition. Due to this heater, the temperature of the swing partition is hot (the swing partition is not defective though it is hot).
- This is not abnormal when you feel heavy while opening or closing the left door which is installed with the swing partition.

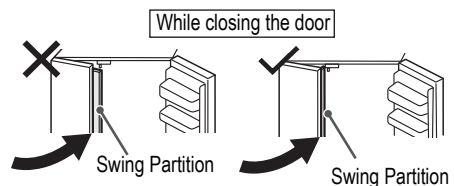
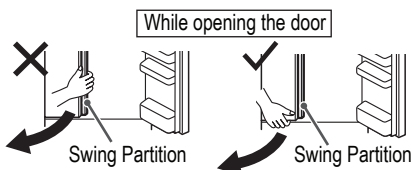

Refrigerator/Selectable Zone/Freezer Compartment

3 How to use the Vacuum Compartment

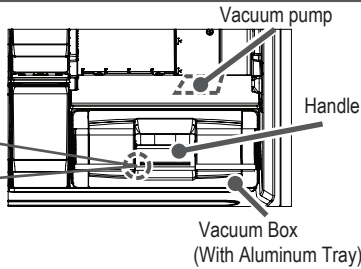
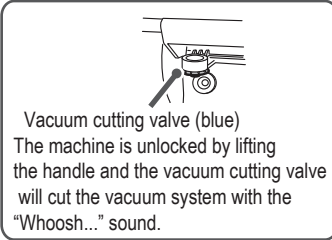

CAUTION

If the lid of the refrigerator is closed but the door of the vacuum case is not closed, there may be some parts will be broken.



■ Open Vacuum Compartment

1. Lift the handle to unlock.

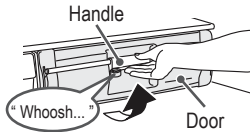

2. Pull the door out.

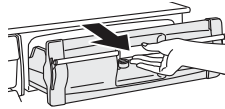

While there is the "Whoosh..." sound, it's still vacuum; thus, the door can not be removed. Please remove the door after the "Whoosh" sound stops.

■ Close Vacuum Compartment

1. Push the vacuum case to the end of the inside.

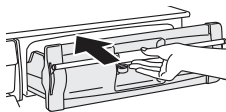

2. Push the handle down to lock the door.

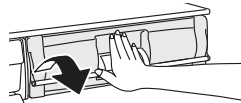

Do not put too much food or too many containers into the vacuum case. if you do, you may not be able to pull the vacuum case out.

Push the handle down to the end. If not, the case might not be vacuumed.

WARNING

Vacuum pump will work when the handle of the vacuum compartment and the door of refrigerator are closed only. When the vacuum pump starts working, there will be loud noise which is not unusual at all. From the vacuum pump starts working until the case becomes vacuumed, it takes around 2 minutes. If the door of the vacuum case opened before 2 minutes, you may not hear the "Whoosh..." sound. Thus, please check the vacuum system after waiting for longer than 2 minutes. Since the vacuum case generates coolness indirectly, it needs more time to cool food than other cases.

With the ability to prevent oxidation, the product can preserve the nutrients and tastes of food longer than conventional food conservation techniques.

● Foods to be stored

Meats/processed meats



Beef/pork/chicken/ham/sausage/etc...

Fishes and seafood



Salmon/mackerel fish/seafood/boiled fish paste/etc...

Vegetables and fruits



Salad vegetables/bell pepper/apple/orange/kiwi/etc...

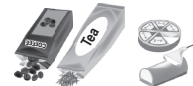

Coffee bean/tea leaf/dairy products/nuggets/etc...

● Food not recommended to be stored

Vegetables vulnerable to low temperature. Skin of the vegetables that are vulnerable to low temperature will sink or change the colors, please store them in vegetable compartment.



Egg plant/cucumber/roselle fruit/asparagus/ginger/sweet pepper/etc...

● Food and containers should be stored with care

Food should be kept in a closed plastic bag. Store the food carefully because the bag will be swollen and press on other food.

Such as sausage and cheese in bags

Be careful



Closed and sealed plastic containers. Please pick containers out carefully because the doors of the containers may be detached.

Be careful



Refrigerator/Selectable Zone/Freezer Compartment

Instructions for disassembly or assembly

1. Slowly lift the front of the vacuum case to detach the core of the door of the vacuum case.
2. Lift the vacuum case higher.

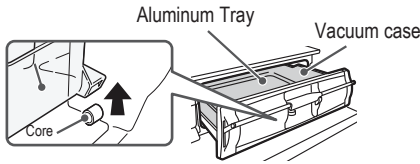

3. Install all parts by following the reverse steps of the disassembly procedure.

CAUTION

- Please remove placed food from the vacuum box before disassembled.
- Please do not detach any part other than the one described in the instruction.
- If you want to disassemble any part not described in the instruction for cleaning, please consult the Service Center through the consultancy channels.
- As for the disassembly or installation of any part, please open the door of the refrigerator wider than 90 degrees.

4 How to remove part

Ice Bank

- To remove Ice Bank, pull Upper Freezer Drawer all the way out, then lift Ice Bank upward.

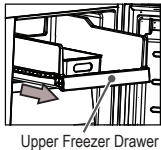

Upper Freezer Drawer



Ice Bank

Vegetable Drawer/Dry-Vegetable Drawer

- To remove Vegetable Drawer and Dry-Vegetable Drawer, pull it all the way out, then lift it upward.

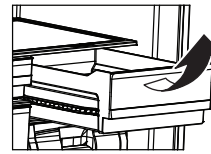

Adjustable-height the Shelves

- The height of these shelves can be adjusted to match the height of your food and the way in which they are to be used.
 - Remove all food stored on the shelf.
 - Lift the back of the shelf upward slightly then pull the shelf out towards to you.
 - Adjust the shelf to the desired height, then push the shelf in until it reaches the back of the slot.



Shelf Trim

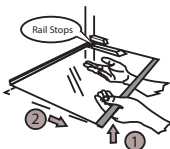

Rail Stops

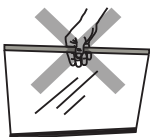

CAUTION

Shelf trims are removable, Holding the shelf with both hands. DO NOT holding trim or holding shelf with only one hand otherwise it may drop or injury.

Utility Drawer

- To remove Utility Drawer, pull it all the way out, then lift it upward.

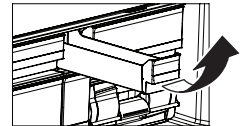

Door Pocket

- Gently tap the left and right of the bottom surface while pulling a pocket up to remove it. When installing the pockets, push it all the way down in a smooth, controlled manner.



Tap!
Tap!

Refrigerator/Selectable Zone/Freezer Compartment

Upper Drawer, Middle Drawer, Lower Drawer (Selectable Zone / Freezer Compartment)

- To remove Upper Drawer, Middle Drawer, Lower Drawer, pull it all the way out, then lift it upward.

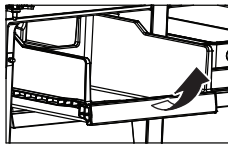

Upper Drawer

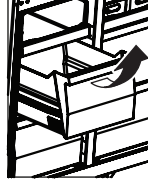

Middle Drawer

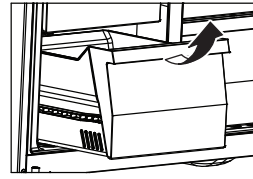

Lower Drawer

Care and Maintenance

Cleaning



WARNING

Make sure to unplug the power plug when maintaining the refrigerator.

When dirt is found Wipe off it immediately. It is recommended to clean the hidden places once a year.

Power plug

- If the power plug is plugged in with dust on the power cord, it can result in fire.
 - Remove all dust once a year and wipe with a dry cloth.



Cleaning once or twice a year

Door gaskets

- This area is prone to smudges, so be sure to wipe it thoroughly.

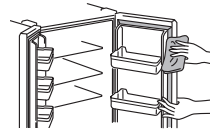

Cleaning once a month

Drawer

- Use a soft cloth wet by lukewarm water to wipe off.

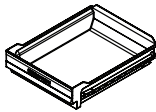

Cleaning once per three months

Door Surface

- To clean the door surface, wipe with a soft cloth wetted with lukewarm water.



Cleaning once a month

Each shelf/pocket

Use a soft cloth wet by lukewarm water to wipe off.

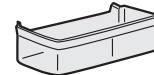

Cleaning once per three months

Drip Catcher

- Liquid that has accumulated here should be wiped away.

Drip catcher

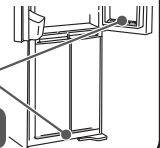

Cleaning once a month

Back Panel, Foot of Refrigerator

1. Turn the leg adjuster to raise the refrigerator up off the floor.
 - If the adjuster does not turn easily, use a screwdriver to turn it. If it still will not turn, then remove the leg cover and try again.
2. Pull the refrigerator straight out toward you.
 - For floors that are easily damaged, lay out a protective mat, or other protective material.
3. Wipe off the smudges on the back panel, walls, and floor of the refrigerator.
 - Due to the convection of air, this is a place where fine dust is likely to adhere.

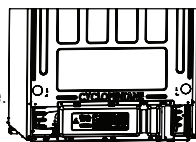

Cleaning once or twice a year

CAUTION

- Do not use the following : An alkaline or weak alkaline kitchen detergent, scouring powder, soap, petroleum, boiling water, scouring pads, acid, benzene, alcohol, or bleach (for details, see the Caution on the detergent package).
- When any cooking oil, citrus fruit juice, or juice from any food pours on this refrigerator, wipe it off.
- When using a chemical rag, be sure to heed the warnings for rag use.
- The doors, painted surfaces, and plastic parts may be scratched, or discolored by the chemical rag.

NOTICE

- Clean regularly surfaces that can come in contact with food and accessible drainage systems.
- If the refrigerating appliance is left empty for long periods, switch off, defrost, dry and leave the door open to prevent mould developing within the appliance.

Care and Maintenance

Ice maker

WARNING

WARNING Do not touch the mechanical parts of the automatic ice maker.

(Touching these parts might result in injury.)



Vacuum Compartment

1. Pull the vacuum box out in order to take the products stored in vacuum box.
2. For the following part, clean it with a piece of cloth soaked in warm water.

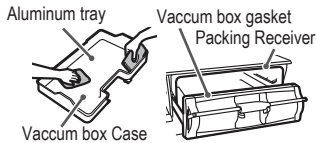

3. Assembly the Vacuum Box case attach with the core of Vacuum Box Door.

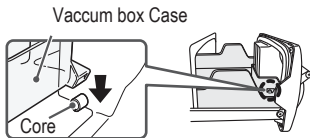

Cleaning once a month

CAUTION

- If the detergent or any product other than warm water is used for cleaning Vacuum Box gasket, there may be effects in terms of deformation, color change or loss vacuum property.
- If Vacuum Box gasket is dropping or Vacuum Box Door not well aligned, there may be the loss of vacuum property.

When Vacuum Box gasket is dirty.

1. Disassembly of Vacuum Box gasket out off Vacuum Box Case. Facing the Vacuum Box, twist the knob of the Vacuum Box gasket on top right and carefully remove.

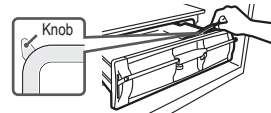

2. Wipe gently with sponge on the stain with plain water. Don't use any detergent.

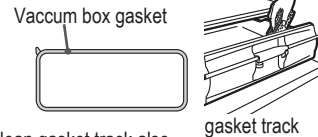

Please clean gasket track also.

3. Wipe water out with dry cloth and leave the part until it is naturally dried.
4. Assemble Vacuum Box gasket, twist the knob to align with the gasket track, deliberately assemble.

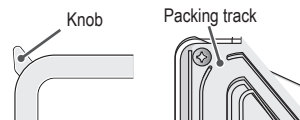

Water tank

In order to prevent grime and hard water stains from building up, make sure to clean the Water Tank once a week.

1. How to open the cover.

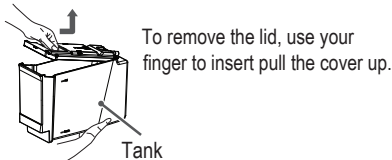

2. How to close the cover.

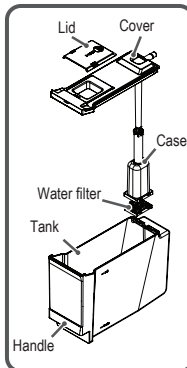
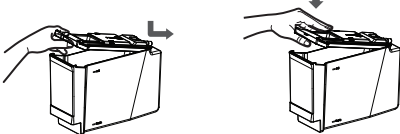

In order to prevent grime and hard water stains from building up, make sure to clean the Water Filter once per week.

1. Pull the case to remove it from the cover.

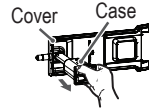

2. Pull the tab to remove the Water Filter from the case.



3. Use a soft sponge to clean the Water Filter.



Do not use cleansers as this may damage the filter.

NOTICE

- If the Automatic Ice Maker is not set to "Stop," the water pump may make sounds occasionally. This is not a malfunction.
- Slide the lid in back-end first in the direction of the arrows to close the lid.
- Replace the Water Filter when it wears out. Water Filters need replacing every 3 to 4 years.
- Clean water tanks if they have not been used for 48 h; flush the water system connected to a water supply if water has not been drawn for 5 days.

Troubleshooting

Before you call for service, please check the following items:

Problem	Things to check	Instructions	Page
The refrigerator does not get cold at all.	<ul style="list-style-type: none"> Is the refrigerator plugged in properly? 	<ul style="list-style-type: none"> Check the fuse box for blown fuse or tripped circuit breaker. 	2
The refrigerator does not get cold enough.	<ul style="list-style-type: none"> Is the refrigerator placed in the direct sunlight? Is the temperature set to "Cold"? Is the food stored too much? Is the door slightly opened? Is the refrigerator placed near heat sources? Has anything hot been placed in the refrigerator? Is the door opened and closed too frequently? 	<ul style="list-style-type: none"> Do not install the refrigerator in a place where it may come in contact with sunlight. Press "Refrigerator" button to normal or coldest. Keep enough space between food. Should close the door firmly closed. Do not install the refrigerator in a place where it may come in contact with heat sources. Make food cool enough before putting in the refrigerator. Do not open & close the door too frequently. 	4 6-7 4-5 - 4 4-5 -
Food in the refrigerator compartment freezes.	<ul style="list-style-type: none"> Is the temperature set to "Coldest"? Do you place food with moisture or vegetables nearby the cold air vent? It will be frozen if it is placed nearby the cold air vent. 	<ul style="list-style-type: none"> Press "Refrigerator" button to normal or cold. Keep enough space between food, Do not block the cold air vent. 	6-7 4-5
Dew appears Outside	<ul style="list-style-type: none"> When the ambient humidity is too high, the door gasket may have dew. Please wipe it up with dry cloth. 	<ul style="list-style-type: none"> See content "Dew or frost is generated" . 	19
Dew appears Inside	<p>Please wipe it off with dry cloth and please check the details below.</p> <ul style="list-style-type: none"> Is the door closed firmly? Is the door opened and closed too frequently or opened for a long time? Is it too humid outside? 	<ul style="list-style-type: none"> See content "Dew or frost is generated" . 	19
The inside is smelling.	<ul style="list-style-type: none"> Do you store food with odor without warpping it? 	<ul style="list-style-type: none"> Using food wrap or sealed containers. 	4-5
The refrigerator is noisy	<ul style="list-style-type: none"> Make sure the refrigerator is installed frimly. Is the refrigerator touching the wall? 	<ul style="list-style-type: none"> Should be install the refrigerator by following the preparing instruction manual. 	4-5

The Control Panel does not respond:

Problem	Things to check	Instructions	Page
The Control Panel display keeps changing	-	<ul style="list-style-type: none"> This indicates that the refrigerator is running is store-display mode. The refrigerator will not cool while running in store-display mode. Turn off the store-display mode by <ol style="list-style-type: none"> Power off and Power on the refrigerator again. After that the refrigerator will return to normal mode. 	-

This is not a malfunction of the refrigerator:



Problem	Things to check	Instructions	Page
The surface of the refrigerator is hot.	-	<ul style="list-style-type: none"> The refrigerator is equipped with the dew prevention and heat radiation tubes. The back and side plates may be heated especially when starting up or if the door is frequently opened and closed. 	-
If a door is shut, other doors may open.	-	<ul style="list-style-type: none"> The two compartments are connected with an air duct. When closing one of the doors, the other door may be opened by the air pressure through the duct. This is a normal phenomenon. 	-
Does the refrigerator make any abnormal noises (sound)?	-	<ul style="list-style-type: none"> The sound like water flowing and boiling water is the sound of the cooling liquid (refrigerant). A creaking sound comes from the storage compartment. It is the sound caused by friction of the parts due to temperature change. 	-
There are waving and / or distortions on the door surface, the side and the top surface of the refrigerator.	-	<ul style="list-style-type: none"> Slight waving and/or distortions are generated in the manufacturing process of the refrigerator. They may be conspicuous according to the position of the light source and/or the brightness etc., but there is no problem with the performance. 	-

Troubleshooting

This is not a malfunction of the refrigerator:

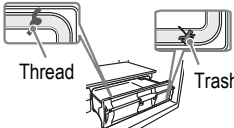
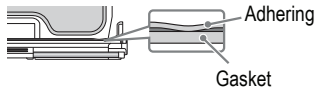

Problem	Things to check	Instructions	Page
Annoying sound is generated by the refrigerator.	-	<ul style="list-style-type: none"> You may feel that the operation sound is loud because the compressor operates in high-speed under the following conditions: the refrigerator does not cool fully on the occasion such as using it for the first time, opening/closing the door frequently, the surrounding temperature is high. The sound becomes more quiet after cooling fully. The compressor operates at low speed at night, or during long vacations or absence. 	-
Operation sound lasts long.	-	<ul style="list-style-type: none"> It is because the compressor operates in low-speed for conserving energy 	-
Operation sound sometimes becomes louder.	-	<ul style="list-style-type: none"> It is because the system changes the operating power of he refrigerator according to the temperature change. 	-

There is something strange with the Vacuum Compartment.





Problem	Things to check	Instructions	Page
<p>In case of occurred these event, Vacuum Compartment might not be operate.</p> 	<ul style="list-style-type: none"> Is the Handle up? Has the Handle been pushed down to the end already? Are Vacuum Compartment gasket and Packing receiver dirty? Is Vacuum Compartment gasket or Vacuum valve (blue) detached or loose. 	<ul style="list-style-type: none"> Push Handle down to the proper position. If not, there is no vacuum. Push the Vacuum Box Case inside to the end and push the handle down to the proper position. If they are, clean them by wiping the stain out. Deliberately attach Vacuum Compartment gasket and vacuum valve. 	- - 15 15
	<ul style="list-style-type: none"> Is there any bag that contains food or stain debris, trash in or around Vacuum Compartment gasket and Packing receiver? 	<ul style="list-style-type: none"> If there is any plastic bag that contains things inside, remove it. If the packings are attached to each other, the Vacuum property will be lost. 	15
	<ul style="list-style-type: none"> Is the gaskets adhered together, gently stretch it part before using the Vacuum Compartment? 	<ul style="list-style-type: none"> If the sides of Packing stick to each other, put them apart. If packing is dirty, clean it. 	15
	<ul style="list-style-type: none"> Has the Vacuum Compartment or R door been opened/closed? 	<ul style="list-style-type: none"> Since the Vacuum Pump is in the status of readiness for work, the absence of the "Whoosh..." sound is not unusual. 	-
It is not known whether it is in the vacuum state or not.	<ul style="list-style-type: none"> If the is the "Whoosh..." sound during the opening, it is normal. 	-	-
The Handle cannot be locked.	<ul style="list-style-type: none"> Is there anything stored in the Packing or the inmost side of the Vacuum Compartment? 	<ul style="list-style-type: none"> If there is, remove that thing. 	-
There is shaking "Bu Bu" sound from around Vacuum Compartment.	<ul style="list-style-type: none"> The sound of Pump creating the vacuum state. If the sound or the shaking happens often, there may be something at the door or the packing may be dirty. 	<ul style="list-style-type: none"> There is nothing wrong. If there is plastic bag, remove it and clean the dirty Packing. 	15
There are dews or water around the door or inside Vacuum Compartment.	<ul style="list-style-type: none"> Water in food and air can cause diets inside because Vacuum Compartment is completely closed. 	<ul style="list-style-type: none"> Anything that contains a lot of water should be wrapped or covered. If there are dews or water, wipe them with a piece of cloth soaked in warm water. 	-
Things stored in Vacuum Compartment are frozen.	<ul style="list-style-type: none"> Is there any vegetable that is vulnerable to low temperature such as cucumber or tomato inside? 	<ul style="list-style-type: none"> Check the vegetables that are vulnerable to low temperature and move them to vegetable compartment. 	12-13

Troubleshooting

Auto Door

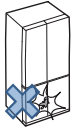
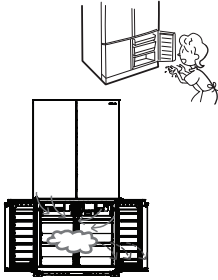
Problem	Things to check	Instructions	Page
Noise loud. There is an abnormal noise.	<ul style="list-style-type: none"> • Hitting sound (thumping sound). • Buzzing sound (whir) (whir). • The operation sound of the Auto Door differs depending on door (left or right). 	<ul style="list-style-type: none"> • This is operating sound of the Aut Door. • This is not malfunction. • This is operating sound of Electric Refrigerator Unit. • This is not malfunction. • This may vary depending on installation conditions of the refrigerator or volume of foods stored in the door pocket. • This is not malfunction. 	-
 Lamp of open button is off or Auto Door won't open even if touching.	<ul style="list-style-type: none"> • Is  lamp not lit? 	<ul style="list-style-type: none"> • Press  button for 5 second or more until lamp on. 	9
The Auto Door dose not close.	<ul style="list-style-type: none"> • Is any food or food bag caught on the compartment? • Did a power failure occur or did the compartment knock against any obstacle during electrical operation? 	<ul style="list-style-type: none"> • Remove food and others that are caught in. • Auto Door function stops on the way, so push in the door with hand. 	-
Auto Door dose not open widely.	<ul style="list-style-type: none"> • Don't stored foods and others make contact with the wall in the Refrigerator Compartment. • Installation site may not be levelled out. 	<ul style="list-style-type: none"> • Remove food and others make contact with the wall. • Opening angle of the Auto Door may vary or the door may go back a little after it is opened automatically depending on installation conditions of the refrigerator, but this is not malfunction. 	-

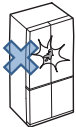
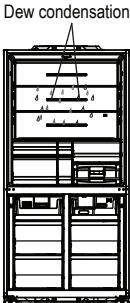
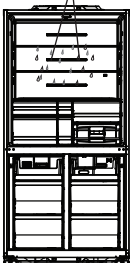
Dew or Frost is generated

General operation	Please check here	Possible causes and / or Recommended solutions
Frost or ice is generated in the freezer compartment	The door of the freezer compartment was not left open temporarily?	Check that the wrapping paper of the food is not getting caught in order not to make gap between door and door gasket when you close the door. 
	The door of the freezer compartment was not opened frequently or longer time than necessary?	When the door is opened frequently or if the door is opened when the humidity around the refrigerator is high, moisture in the air may be turned into some frost or ice on the inner wall or component of the freezer compartment, or around the air channels. This is not a failure. Please try not to open the door too many times or for a long time. Also, please wipe frost or ice generated in the freezer compartment off with use of a dry cloth. 
	Making extra ice by using an additional ice-tray which was not originally installed in the refrigerator?	When the many containers in which water or liquid is stored are put in the same time, water or liquid may be evaporated and turned into frost or ice on the wall or component of the freezer compartment, or around the air channels. You can suppress these frost and ice by putting lid to avoid evaporation. Please wipe frost and ice off with use of a dry cloth. 
Dew is generated in the refrigerator compartment	The door of the refrigerator compartment was not left open temporarily?	Please check not to pinch the food or plastic bag between the door and door frame when you close the door. 
	The door of the refrigerator compartment was not opened frequently or longer time than necessary?	When the door is opened frequently or if the door is opened when the humidity around the refrigerator is high, moisture in the air may be turned into some dew on the inner wall or component of the refrigerator compartment, or around the chilled air blow-off port. This is not failure. Please try not to open the door too many times or for long time. Also, please wipe off the dew in the refrigerator compartment with adry cloth. 
	Storing many vegetables containing much water?	The humidity of the vegetable compartment is higher than other compartments. Accordingly, depending on the amount or type of the vegetable, dew condensation may be generated on the plastic case of vegetable compartment. However, this is not a failure. When you do not want to have this kind of dew, please warp your vegetables in a plastic flim. Also, when the dew condensation happens many times, water may be accumulated in the vegetable compartment. Please wipe the water off with a dry cloth. 
Dew is generated on outer surface of the refrigerator	The volume of humidity around the refrigerator is not high?	When the humidity rises such as in rainy day, some dew many be generated on the outer surface of the refrigerator. Please wipe the dew off with a dry cloth. 
	The temperature setting is not set as "Coldest"?	When the temperature setting is set as "Coldest", some dew may be generated on the outer surface of the refrigerator. Please set the setting as "Normal". Also, please wipe dew off with use of a dry cloth. 

Why frost and dew are generated?

When warm and humid air contacts something cold, dew is generated. For example, if you put some ice in the glass in your room, air around the glass will be cold down and some dew may be generated on the outer surface of the glass.

In the same way, when warm and humid air enters into the refrigerator at the door opening, the warm and humid air contacts cold inner wall and little dew may be generated.

Accordingly, if the door opening is too frequent or too long, dew will be accumulated at every door opening. In some cases, dew may be frozen to generate some frost or ice flakes in the freezer compartment.

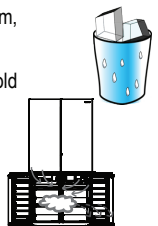

Service Center

- Before you request repair, please check the refrigerator well according to page number 16-18. If it is still abnormal, please contact the retailer of purchase or the following service center.

Customer Service Center

Beko A&NZ Pty Ltd
55 Blanck Street, Ormeau, QLD 4208
Official Distributor of Hitachi Home Appliances
Phone: 1300 470 552
Web: www.hitachi-homeappliances.com/au-en/

- Telephone number is subject to change without notice.

About Non-fluorocarbon refrigerator

- This refrigerator, including refrigerant and the heat insulator, is using hydrocarbon (non-fluorocarbon). The hydrocarbon is a material that does not rip up the ozone and have very little influence on global warming. It is the global environment concern material).
- R600a refrigerant is flammable. But the refrigerant is sealed up by the refrigerant circuit, and never leaks by usual use. In case of the refrigerant circuit being damaged by any chance, please avoid using fire or electric product, open the window and ventilate. Afterwards, please contact Hitachi Service Center.

Sever warning signs for Disposal

Cyclopentane is used as in the insulation. The gases in insulation material require a special disposal procedure.
Please contact your local authorities in regard to the environmentally safe disposal of this product.



This symbol mark means that used electrical and electronic products shall not be mixed with general household waste. Do not try to dismantle the system and unit by yourself as this could have harmful effects on your health and the environment. Refrigerators must be treated at a specialized treatment facility for recycling and recovery and shall not be disposed of in the municipal waste stream. Please contact the installer, dealer or local authority for more information.



430-HRPK2485A_INST-B-FBF560LUX-AUS (AB)